

# Data Sheet



Article number: 021500700075

Description: Sealing Clamp S 75 W5

## Measures

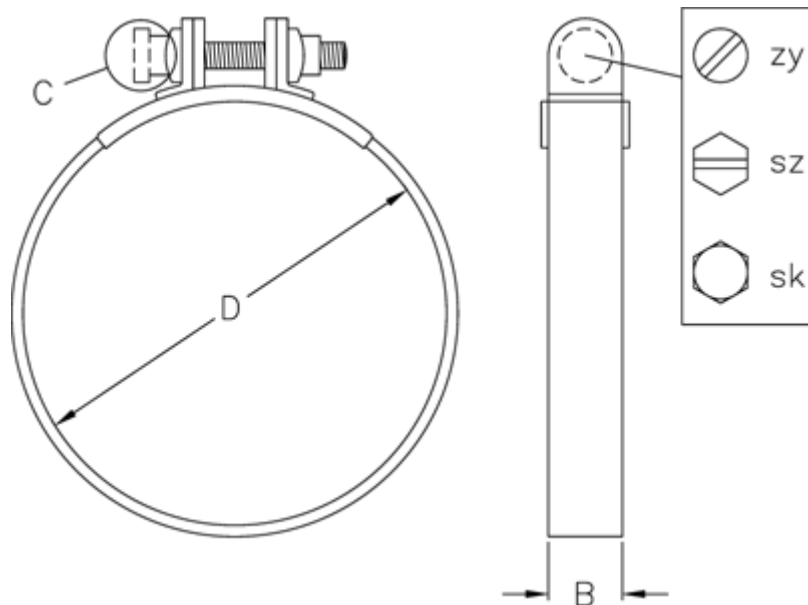

C (screw type) = SZ

Diameter D = 75

Width B = 20